

Features

- DALI or PUSH dimmable
- Current adjustable via DIP switch
- 1% dimming depth; standby power consumption <0.5W
- Supports corridor function (corridor DIM) and emergency escape lighting system
- Suitable for Class II light fixtures
- 5-year warranty (please refer to the warranty condition)



Applications

· Indoor office lighting · commercial lighting · residential lighting

Descriptions

LF-ADD040-1050-42 is a 40W DALI or PUSH dimmable constant current LED driver supporting corridor function (corridor DIM) and emergency escape lighting system via Lifud programmer. Its input voltage ranges from 220 to 240Vac and output current is adjustable via DIP switch from 700 to 1050mA with every 50mA as a step. It has all-round protections: over voltage protection and short circuit protection.

Product Model

LF - ADD 040 - 1050 - 42

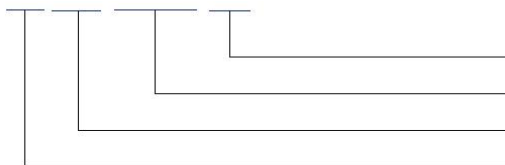

- 42: max. output voltage: 42Vdc
- 1050: max. output current: 1050mA (e.g. 1050: 1050mA)
- 040: output power: 40W (e.g. 040: 40W)
- ADD: DALI dimmable LED driver

Lifud Technology Co., Ltd.

Production Base I (HQ): Building B, Kutto Industrial Park, NO.26 Xinhe Road, Bao'an District, Shenzhen, China.
 Production Base II: No.4, Block 2, Tengfei Road, Shigao Economic Development Zone, Tianfu New Area, Sichuan, China.
 Website: www.lifud.com Telephone: +86(0)755 8373 9299 Email: sales@lifud.com

■ Electrical Characteristics

Model		LF-ADD040-1050-42							
Output	Output Voltage	9-42Vdc							9-40Vdc
	Output Current	700mA	750mA	800mA	850mA	900mA	950mA	1000mA	1050mA
	Flicker Index (Modulation Depth)	IEC-Pst ≤ 1 , CIE SVM ≤ 0.4 Complies with IEEE Std 1789-2015							
	Current Tolerance	$\pm 5\%$							
	Temperature Drift	$\pm 10\%$							
	Start-up Time	<2S							
Input	AC Input Voltage	220-240Vac (voltage limit: 198-264Vac)							
	DC Input Voltage	180-264Vdc							
	Input Frequency	50/60Hz							
	Input Current	0.3A max.							
	PF	>0.97							
	THD	<20%							
	Efficiency	$\geq 87\%$							
	Inrush Current	<25A&200uS							
	Load Quantities of Circuit Breaker	Model	B10	C10	B16	C16			
		Quantity (pcs)	23	38	37	61			
	Leakage Current	<0.7mA							
Standby Power Consumption	$\leq 0.5W$ (when PWM OFF signal is effective)								
Protection Characteristics	Open Circuit	<59V							
	Short Circuit	Hiccup mode (auto-recovery)							
Environment Descriptions	Operating Temperature	-30°C - +45°C							
	Operating Humidity	20-95%RH (no condensation)							
	Storage Temperature/ Humidity	-30°C - 80°C (6 months in Class I environment); 20-75%RH (no condensation)							
	Atmospheric Pressure	86-106kPa							

■ Electrical Characteristics

Safety & EMC	Certifications	TUV-ENEC, CE, CB, RCM, EL, UKCA, CCC
	Withstand Voltage	I/P-O/P: 3.75kV 5mA 60S; I/P-DA1/DA2: 1.5kVac 5mA 60S; O/P-DA1/DA2: 0.5kVac 5mA 60S
	Insulation Resistance	I/P-O/P: >100MΩ@500Vdc; I/P-DA1/DA2: >100MΩ@500Vdc; O/P-DA1/DA2: >100MΩ@500Vdc
	Safety Standards	ENEC: EN61347-1: 2015, EN 61347-2-13: 2014/A1: 2017, EN 62384: 2016/A1: 2009 CE-LVD: EN 61347-2-13: 2014/A1: 2017, EN 61347-1: 2015, EN 62493: 2015 CB: IEC 61347-1: 2015, IEC61347-2-3: 2014, IEC 61347-2-13: 2014/AMD1: 2016 RCM: AS 61347.2-13: 2018 EL: IEC 61347-2-13: 2014 Annex J UKCA: BS EN IEC 55015: 2019+A11: 2020, BS EN 61547: 2009, BS EN IEC 61000-3-2: 2019, BS EN 61000-3-3: 2013/A2: 2021 CCC: GB19510.1-2009, GB19510.14-2009
	EMI	CE-EMC/RCM: EN55015, EN61000-3-2, EN61000-3-3 CCC: GB/T17743, GB17625.1, GB17625.2
	EMS	CE-EMC/RCM: EN61000-4-2, 3, 4, 5 (lightning strike: 1kV), 6, 11 CCC: GB/T17626.2, 3, 4, 5 (lightning strike: 1kV), 6, 11
Other Parameters	IP Rating	IP20
	RoHS	RoHS 2.0 (EU) 2015/863
	DALI Standard	IEC62386-101 102 207: DALI2.0
	Noise Level	≤29dB (this data is measured in a soundproof room and the noise collector should be 10CM away from LED driver)
	Warranty	5 years (Tc≤80℃)
Test Equipment	AC power source: CHROMA6530, digital power meter: CHROMA66202, oscilloscope: Tektronix DPO3014, DC electronic load: M9712B, LED board, constant temperature and humidity chamber, lightning surge generator: Everfine EMS61000-5B, rapid group pulse generator: Everfine EMS61000-4A, spectroanalyzer: KH3935, Hi-pot tester: EEC SE7440, flicker tester (flicker-free coefficient test): Everfine LFA-3000, etc.	
Test Remark	If there are no special remarks, the above parameters are tested at the ambient temperature of 25℃, humidity of 50%, full load and input voltage of 230Vac/50Hz.	

■ **Electrical Characteristics**

Additional Remarks	<ol style="list-style-type: none"> 1. It is recommended that user install the over voltage protection, under voltage protection and surge protection devices in the power supply circuits of light fixtures to ensure electricity safety. 2. The LED driver used in combination with the end device is one of the accessories of the whole light fixture, and the EMC of the whole light fixture is not only susceptible to the driver itself, but to the LED light fixture and the whole light fixture's wiring. Thus, the manufacturer of LED light fixture should re-confirm the EMC of the whole light fixture before the whole light fixture is finished. 3. The test conditions of the circuit breaker configuration quantity are the same as those of the inrush current. 4. The PC cover, casing and end cap for assembling the LED driver in the light fixture must meet the fire rating of UL94-V0 or above. 5. Please disconnect AC when switching the current shift; connect AC after adjusting the DIP switch to the according current.
---------------------------	---

■ **Product Characteristic Curves**

PF Curve

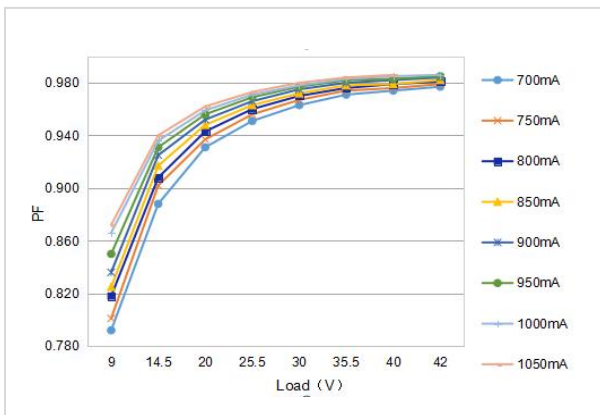

Efficiency Curve

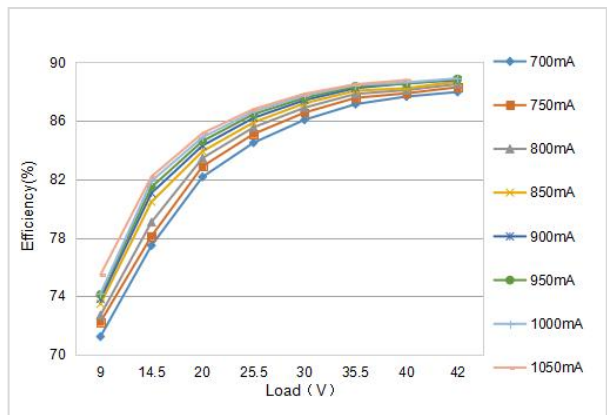

Lifetime Curve

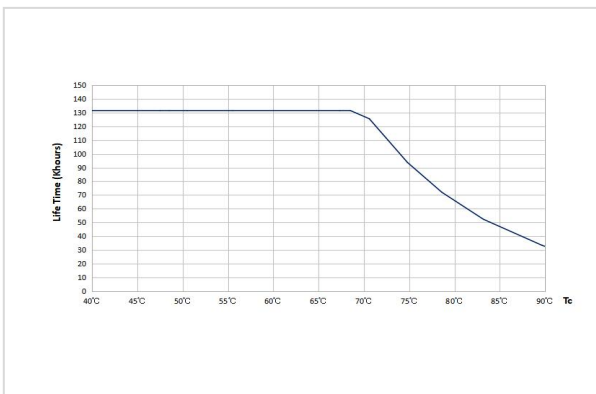

Tc Point Test Diagram

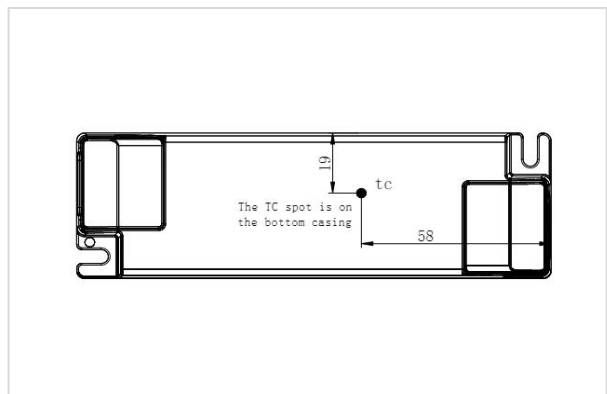

■ **Product Definitions**

Product Terminals

INPUT		OUTPUT	
DA1/PUSH	DA1/PUSH dimming input	LED+	Positive electrode output of LED driver
DA2/PUSH	DA2/PUSH dimming input	LED-	Negative electrode output of LED driver
AC-L	Input terminal of AC live wire		
AC-N	Input terminal of AC neutral wire		

Product DIP Switch

Vo DC	I rated (CC)	1	2	3
9-40V	1050mA	OFF	OFF	OFF
9-42V	1000mA	OFF	OFF	ON
9-42V	950mA	OFF	ON	OFF
9-42V	900mA	OFF	ON	ON
9-42V	850mA	ON	OFF	OFF
9-42V	800mA	ON	OFF	ON
9-42V	750mA	ON	ON	OFF
9-42V	700mA	ON	ON	ON

Remark: when adjusting the output current via the DIP switch, please disconnect input AC first so as to use the DIP switch without the input AC connected.

Wiring Diagram of PUSH Dimming

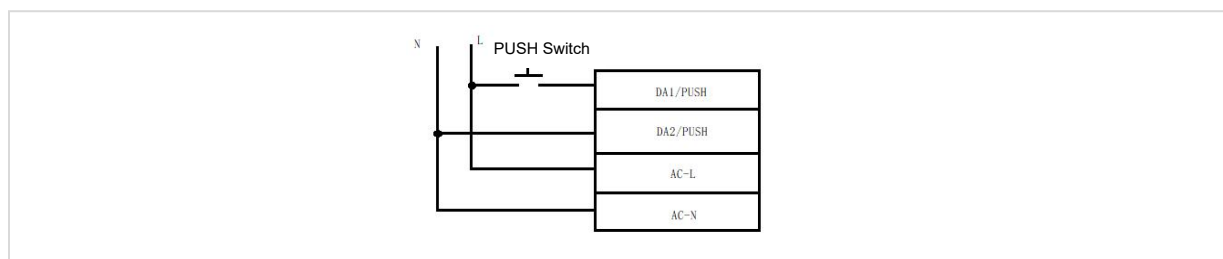

PUSH Dimming Operations

- Connect the PUSH switch in series between AC-L and DA1 PUSH terminals; connect AC-N to DA2 PUSH terminal.
- Do not directly connect AC-L and AC-N to DA1/PUSH and DA2/PUSH terminals.
- Before the mains is connected, please ensure that the PUSH switch is disconnected. After that, the PUSH operation can be performed.
- Before the mains is disconnected, please ensure that the PUSH switch is disconnected.
- Shall you have any questions about the wiring or the other operation method, please contact Lifud FAE team.
- Any improper wiring or other operation method may lead to the damage of driver.

■ Dimming Operation Instructions

PUSH Dimming Operations

Operation	Duration	Function
Instant Push	0.1-0.5 sec	LED light on/off
Long Push	0.6-9 sec	Dim up/down the light
Reset Push	>9 sec	Reset to 50% brightness

- The PUSH operation won't cause any variations on LED driver if it's less than 0.1S.
- Min. dimming depth of PUSH dimming: 1% (lout)
- The PUSH dimming mode has the memory function in case of any power failure. When the LED driver is powered on again, the light will return to the previous state before power failure.
- The present PUSH dimming direction is opposite to the former one.
- Max. wire length from the PUSH switch to the farthest LED driver: 135m; wire diameter: 12-24AWG
- Max. quantity of drivers connected in parallel in DALI dimming mode: 64 pcs.
- Press for 3+ mins to switch to corridor lighting (see the instructions of corridor dimming mode).

Wiring Diagram of DALI Dimming

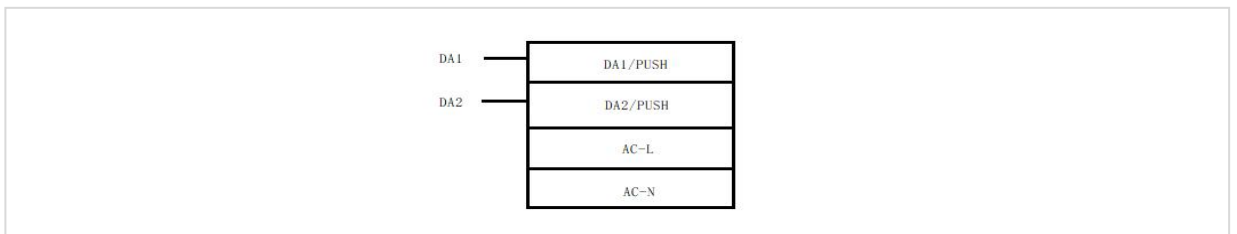

DALI Dimming Operations

- Default setting: 100% brightness
- Connect DALI signal to DA1 PUSH & DA2 PUSH terminals.
- DALI protocol includes up to 16 group scenes
- Max. quantity of drivers connected in parallel in DALI dimming mode: 64 pcs.
- Min. dimming depth of DALI dimming: 1%

DALI Dimming Curve (linear)

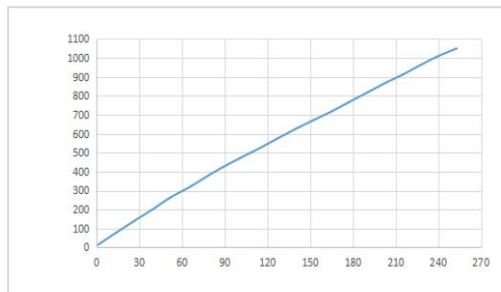

DALI Dimming Curve (logarithmic)

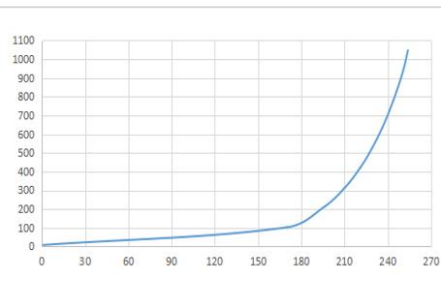

⚠ Choose only ONE as opposed to use DALI or PUSH or corridor dimming at the same time in case of the damage of DALI master.

■ **Dimming Operation Instructions**

Wiring Diagram of Corridor Dimming (sensor switch)

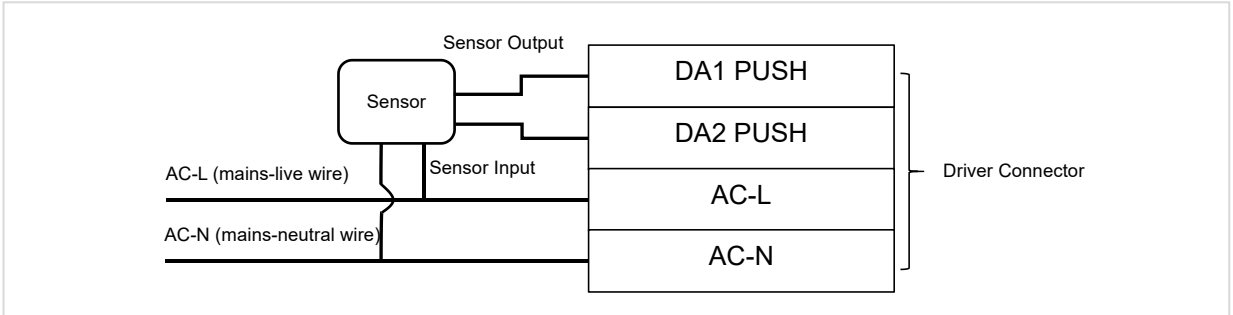

Operations for Entering Corridor Lighting Mode

- **Approach 1:** keep moving in the effective sensing area for 3+ mins (set the sensor's hold time for 3+ mins) to enable the corridor dimming mode;
- **Approach 2:** replace the sensor with an ordinary switch and keep it on for 3+ mins so as to switch to the corridor dimming mode (automatically);
- **Approach 3:** use Lifud programmer to enable the driver's corridor dimming mode and set parameters.
- Remarks:
 1. Entering phenomena: long press on the PUSH button (default to be the PUSH operation), the brightness will reset to 50%; when the driver enter the corridor dimming mode. From perception, it dims down and then dims up;
 2. After enabling the corridor dimming mode, PUSH DIM is turned off;
 3. When the mains is connected, the driver will enter the brightness at any stage of the corridor lighting mode; switching to DC and then reconnecting AC (mains), the driver will return to the corridor lighting mode, and the corridor lighting mode is implemented from scratch.

Operations for Exiting Corridor Lighting Mode

- **Approach 1:** connect to DALI master and send DALI command, the driver will return to the DALI dimming mode.
- **Approach 2:** connect to the PUSH switch and continuously press it 10 times within 10 secs, the driver will return to the PUSH dimming mode.
- **Approach 3:** use Lifud programmer to choose other modes and exit corridor lighting mode.
- Remarks:
 1. The 3-sec or above single press or release will cause the press number (10 times) to be counted as 0. If so, please repress the PUSH switch 10 times within 10 secs
 2. The corridor lighting mode of driver will NOT be exited if it is set via Lifud programmer.

■ Dimming Operation Instructions

Working Process of Corridor Dimming Mode

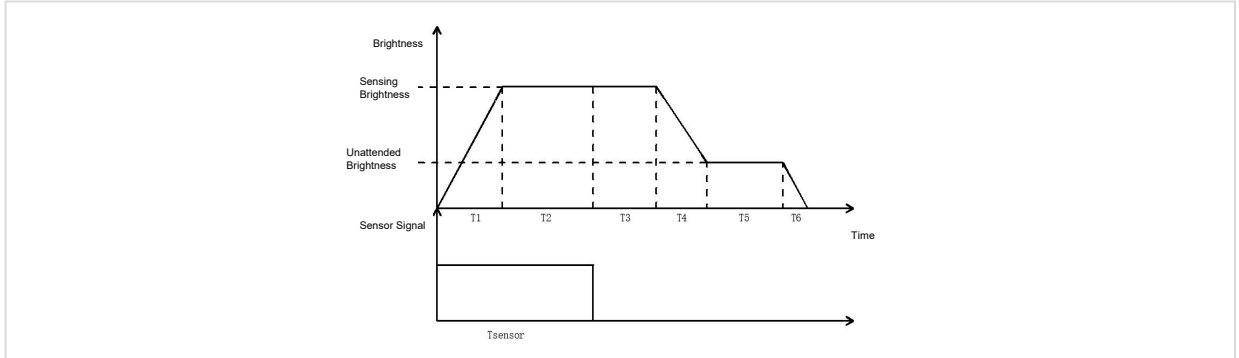

		Default Value	Available Setting Scope
T1	Fade-in time of sensing	1 sec	0-100 sec(s)
T2	Hold time of sensing	Depends on sensor	Depends on sensor
T3	Wait time of sensing	180 secs	0-59999 sec(s); 60000 secs (∞)
T4	Fade-out time of sensing	5 secs	0-100 sec(s)
T5	Unattended time	60000 secs (∞)	0-59999 sec(s); 60000 secs (∞)
T6	Fade-out to off time	0 sec	0-100 sec(s)
	Sensing brightness	100%	0-100%
	Unattended brightness	10%	0-100%

Operations for Emergency Escape Lighting System

When there is no mains input, the driver switches to the emergency escape lighting system; driver's output: 15% (Iomax)
 Emergency input voltage: 180-264Vdc

Remarks:

1. The emergency output current is settable via Lifud programmer and programming software
2. Max. setting: 15%.
3. When the emergency escape lighting function is off, in the case of DC input, the driver will have no output.
4. In the case of mains input, the brightness is random when using PUSH dimming, disconnect AC (mains) and connect DC, the driver will enter the emergency escape lighting system; disconnect DC and connect AC (mains), the light brightness will remain the one set via PUSH switch when mains is connected.
5. In the case of mains input, the brightness is random when using DALI dimming, disconnect AC (mains) and connect DC, the driver will enter the emergency escape lighting system; disconnect DC and connect AC (mains), the light brightness will return to the max. default DALI brightness.

■ **Structure & Dimensions (unit: mm)**

Product Dimensions

Model	Overall Appearance (L*W*H)	Center-to-center Spacing of Positioning Hole	Diameter of Positioning Hole
LF-ADD040-1050-42	145.0*46.0*27.5 mm	131.1 mm	3 mm

Structure Diagram

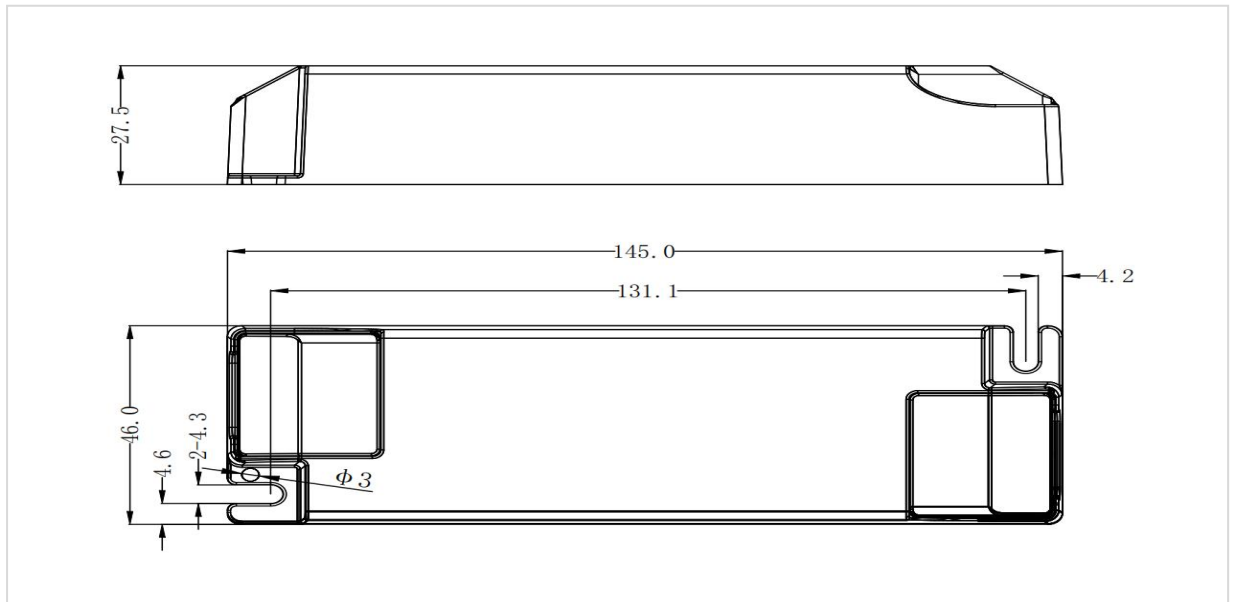

■ **Packaging Specifications**

Model	LF-ADD040-1050-42
Carton Size	385*285*210 mm (L*W*H)
Quantity	10 pcs/layer; 7 layers/ctn; 70 pcs/ctn
Weight	0.123 kg/pc; 9.62 kg/ctn

■ Transportation & Storage

1. Transportation

- Suitable transportation means: vehicles, boats and aeroplanes.
- In transit, it is necessary to prepare awnings for rain or sun protection. Moreover, please keep civilized loading and unloading to prevent the vibration or impact of LED driver as much as possible.

2. Storage

- The storage of LED driver shall conform to the standard of Class I environment. When using LED drivers which have been stored for more than 6 months, please re-test them firstly. Do not use them unless they are tested to be qualified.

Cautions

- Please use Lifud LED driver according to its parameters in the specification, otherwise the LED driver may malfunction.
- Using any incompatible light fixtures or those that have not been certified may cause fire, explosion or other risks.
- Man-made damage is beyond the scope of Lifud warranty service.

Remark: Lifud Technology Co., Ltd. reserves the right to interpret any contents of this specification.